

Data Sheet



Article number: 20165634

Description: E+G Cabinet U-handle GN 426-AL-20-300-BL

Measures

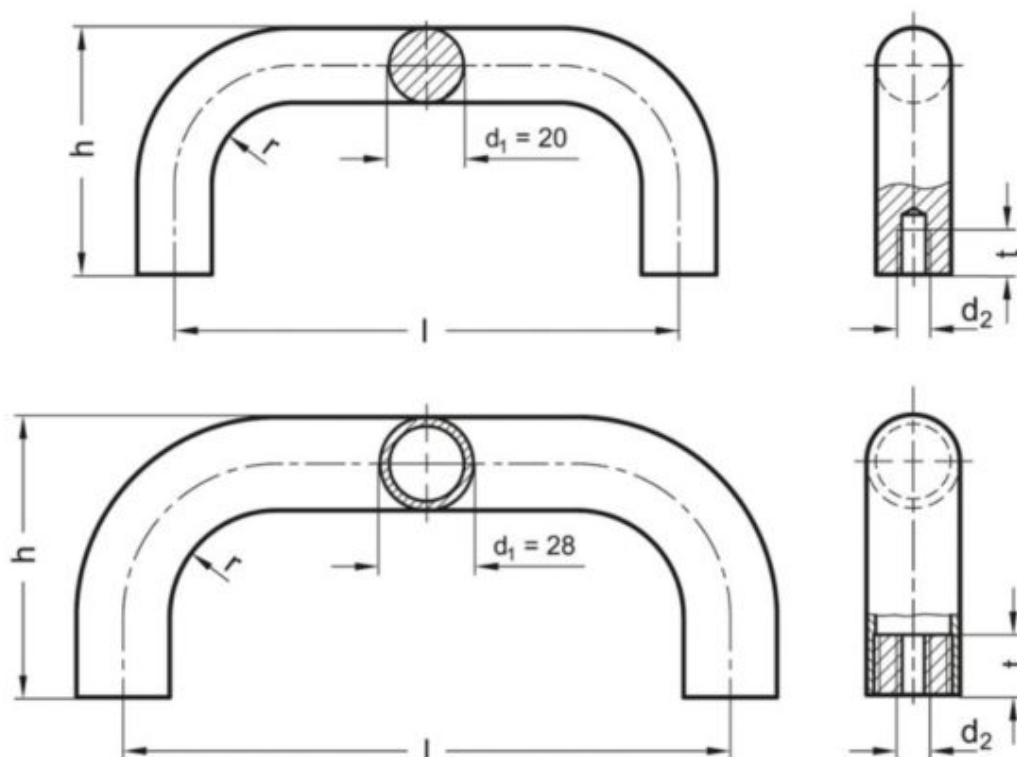

d_1	= 20
d_2	= M8
h	= 68
l	= 300
r	= 22
t_{min}	= 15